

# Open Networks Project

## Operational DER visibility and monitoring

Use cases, Volumes, and DER Data Points

July 2021 | Version 1.1

## WS1B P6 Operational DER Visibility and Monitoring

Use cases, Volumes, and DER Data Points  
July 2021

### DOCUMENT CONTROL

#### Authorities

| Version | Issue Date | Authorisation                | Comments |
|---------|------------|------------------------------|----------|
| 1.1     | 30/07/21   | Open Networks steering group |          |

#### Change history

| Version | Change reference | Description  |
|---------|------------------|--|
| 1       | 02/07/21         | DNOs and ESO created the use cases and volumes for DER monitoring and visibility |
| 1.1     | 19/07/21         | Integrated comments from product team.   |

#### Acknowledgement

We would like to thank P6 stakeholders for their contributions to this report and wider WS1B P6 deliverables including Matthew White, Matthew Rivett, Ali R. Ahmadi, Odilia Bertetti, Avi Aithal, Steve Davanport, Sven Hoffmann, Steve Gough, Malcolm Grisdale, Grant Mcbeath, Daniel Burke, John Stapleton, Paul Simpkin, Flo Silver, and Christopher Surgeoner.

**TABLE OF CONTENTS**

- 1. Introduction ..... 5
  - 1.1. About ENA..... 5
  - 1.2. About Open Networks..... 5
    - 2021 Open Networks Project Workstreams..... 6
  - 1.3. Our members and associates ..... 6
    - ENA members..... 6
    - ENA associates..... 6
  
- 2. Scope and Approach..... 7
  - 2.1. Background to the product..... 7
  - 2.2. Requirements of the product..... 7
  - 2.3. Outputs..... 8
  - 2.4. Approach and Methodology..... 8
  
- 3. Operational DER data Definition and Scope..... 9
  - 3.1. Operational DER Data Definition..... 9
  - 3.2. DER in Scope..... 11
  
- 4. Use Cases Definition..... 12
  - 4.1. DER providing service to DNO only ..... 12
    - 4.1.1. Flexible Connections dispatch..... 12
    - 4.1.2. Flexibility Service Dispatch ..... 13
  - 4.2. DER providing service to ESO only..... 13
    - 4.2.1. Ancillary and Balancing Services..... 13
    - 4.2.2. System Restoration (Black Start) ..... 14
    - 4.2.3. Capacity Mechanism Planning..... 14
  - 4.3. DER providing service to a DNO and ESO ..... 14
    - 5.3.1. Conflict of Services..... 14

|      |  |    |
|------|--|----|
| 4.4. | All DER – Improvement of existing processes..... | 15 |
| 4.5. | Market Facilitation .....                        | 18 |
| 5.   | Volume and Impact of Use Cases .....             | 20 |
| 6.   | DER Data Points identification.....              | 22 |
| 7.   | DER Data Points to Use Case Mapping.....         | 24 |

## 1. Introduction

### 1.1. About ENA

Energy Networks Association (ENA) represents the owners and operators of licenses for the transmission and/or distribution of energy in the UK and Ireland. Our members control and maintain the critical national infrastructure that delivers these vital services into customers' homes and businesses.

ENA's overriding goals are to promote UK and Ireland energy networks ensuring our networks are the safest, most reliable, most efficient and sustainable in the world. We influence decision-makers on issues that are important to our members. These include:

1. Regulation and the wider representation in UK, Ireland and the rest of Europe
2. Cost-efficient engineering services and related businesses for the benefit of members
3. Safety, health and environment across the gas and electricity industries
4. The development and deployment of smart technology
5. Innovation strategy, reporting and collaboration in GB

As the voice of the energy networks sector, ENA acts as a strategic focus and channel of communication for the industry. We promote interests and good standing of the industry and provide a forum of discussion among company members.

### 1.2. About Open Networks

Britain's energy landscape is changing, and new smart technologies are changing the way we interact with the energy system. Our Open Networks project is transforming the way our energy networks operate. New smart technologies are challenging the traditional way we generate, consume and manage electricity, and the energy networks are making sure that these changes benefit everyone.

ENA's Open Networks Project is key to enabling the delivery of Net Zero by:

6. opening local flexibility markets to demand response, renewable energy and new low-carbon technology and removing barriers to participation
7. providing opportunities for these flexible resources to connect to our networks faster
8. opening data to allow these flexible resources to identify the best locations to invest
9. delivering efficiencies between the network companies to plan and operate secure efficient networks

We're helping transition to a smart, flexible system that connects large-scale energy generation right down to the solar panels and electric vehicles installed in homes, businesses and communities right across the country. This is often referred to as the smart grid.

The Open Networks project has brought together the nine electricity grid operators in the UK and Ireland to work together to standardise customer experiences and align processes to make connecting to the networks as easy as possible and bring record amounts of renewable distributed energy resources, like wind and solar panels, to the local electricity grid.

The pace of change Open Networks is delivering is unprecedented in the industry, and to make sure the transformation of the networks becomes a reality, we have created six workstreams under Open Networks to progress the delivery of the smart grid.

## WS1B P6 Operational DER Visibility and Monitoring

Use cases, Volumes, and DER Data Points  
July 2021

### 2021 Open Networks Project Workstreams

- WS1A: Flexibility Services
- WS1B: Whole Electricity System Planning and T/D Data Exchange
- WS2: Customer Information Provision and Connections
- WS3: DSO Transition
- WS4: Whole Energy Systems
- WS5: Communications and Stakeholder Engagement

### 1.3. Our members and associates

Membership of Energy Networks Association is open to all owners and operators of energy networks in the UK.

- ▶ Companies which operate smaller networks or are licence holders in the islands around the UK and Ireland can be associates of ENA too. This gives them access to the expertise and knowledge available through ENA.
- ▶ Companies and organisations with an interest in the UK transmission and distribution market are now able to directly benefit from the work of ENA through associate status.

#### ENA members



#### ENA associates

- |  |  |                                  |
|--|--|----------------------------------|
| 10. <a href="#">Chubu</a>                    | 13. <a href="#">Heathrow Airport</a>           | 16. <a href="#">Network Rail</a> |
| 11. <a href="#">EEA</a>                      | 14. <a href="#">Jersey Electricity</a>         | 17. <a href="#">TEPCO</a>        |
| 12. <a href="#">Guernsey Electricity Ltd</a> | 15. <a href="#">Manx Electricity Authority</a> |                                  |

## 2. Scope and Approach

### 2.1. Background to the product

On Friday 9 August 2019, a power outage caused interruptions to over 1 million consumers' electricity supply. During this event, a large amount of DG tripped or de-loaded resulting in demand disconnection being triggered in order to protect the system and bring system frequency back under control.

Following this event, Ofgem opened an investigation into the power outage which resulted in nine specific and measurable actions. Action eight highlighted the need for Ofgem to investigate and consider options to improve real time visibility of DG to DNOs and the ESO<sup>1</sup>.

In August 2020, Ofgem published a call for evidence on DG visibility, highlighting the shortfall in the collection and recording of real-time data associated with distributed generation, clearly signalling their intention to establish a policy on DER monitoring requirements<sup>2</sup>.

The industry responses received to the call for evidence agreed that there are significant shortfalls in DG visibility. However, Ofgem noticed a lack of articulated set of use cases for DG data visibility, and agreed that further industry analysis was required to inform policy decisions. Ofgem has then directed the Energy Networks Association (ENA) Open Networks Project (ONP) to work with network companies and relevant stakeholders to provide a clearer articulation on exactly how enhanced DG visibility would contribute to assisting the Electricity System Operator (ESO) and Distribution Network Operators (DNOs) at present and in the future; what data measurements enhanced visibility of DG should include; the costs and benefits of enabling such visibility; and how governance changes should be implemented<sup>3</sup>.

### 2.2. Requirements of the product

The requirement of WS1B P6 Operational DER visibility and Monitoring, defined in the Product Initiation Document (PID) are outlined below:

- ▶ To identify use cases for DER visibility and monitoring for the ESO and DNOs
- ▶ To quantify the number of real world examples that fall under each use
- ▶ To identify the data parameters that must be captured (MW output etc.)
- ▶ To define the functional specifications for these use cases, which include:
  - Resolution of data capture (seconds, milliseconds etc.)
  - The means by which data should be transferred to the ESO and/or DNO and associated latency (ICCP links, half hourly data transfer etc.)
  - To identify if the use cases and requirements vary due to DG and DER size and voltage connection.

---

<sup>1</sup> . <https://www.ofgem.gov.uk/publications-and-updates/investigation-9-august-2019-power-outage>

<sup>2</sup> <https://www.ofgem.gov.uk/publications/call-evidence-visibility-distributed-generation-connected-gb-distribution-networks>

<sup>3</sup> [https://www.ofgem.gov.uk/sites/default/files/docs/2021/02/next\\_steps\\_on\\_the\\_visibility\\_of\\_dg.pdf](https://www.ofgem.gov.uk/sites/default/files/docs/2021/02/next_steps_on_the_visibility_of_dg.pdf)

- ▶ Use these to derive a cost-benefit analysis framework for DER visibility and monitoring against the use cases, as below.
  - Cost:
    - Quantify the investment that would be required for monitoring, collecting, storing and disseminating real time operational data associated with DG
    - Define which party should be responsible for these investments
    - Assess if the cost varies based on the size of visible DG
  - Benefits:
    - Quantify the value that additional data points will provide to improving the planning, security and real time operation of the GB transmission and distribution systems
    - Quantify the value will the above characteristics provide to improving DSO function delivery including network management, flexibility procurement, and service conflict avoidance by the DNOs or other stakeholders

### 2.3. Outputs

This work will provide inputs to inform the development of the policy on DER monitoring requirements including to the proposed grid code modification GC0139: 5 ‘Enhanced Planning-Data Exchange to Facilitate Whole System Planning’, which seeks to increase the scope and detail of planning-data exchange between DNOs and the ESO to help facilitate the transition to a smart, flexible energy system. This modification proposes to enhance and align certain data exchange processes, providing greater granularity of data on a range of operating conditions; this will help facilitate improved coordination and more efficient planning of the networks for all parties. This modification is at the workgroup stage, but it has the potential to increase the visibility of the operational characteristics of DG.

This report constitutes the key outputs “A” and “B” of the product deliverables for the year, as identified in PID-2021.

### 2.4. Approach and Methodology

Figure 1 below summarises the approach to deliver WS1B P6 outputs on Operational DER visibility and monitoring.

The first step has been the identification of current and future use cases that would benefit from an enhanced DER visibility, both at transmission and at distribution level. The frequency of occurrence of the use case as well as the impact that no or partial DER visibility has on the specific use case, has then been assessed, specifically looking at the perspective of network and commercial risk as well as at stability of the GB system.

A comprehensive set of DER data points has then been identified and mapped to the use cases through a priority flag in terms of “Essential”, “Desirable” or data point “Not required” as applicable to individual use case. The complete list of use cases to data points mapping is available in Table 18, Table 19 and

| E                | D                | N                   |
|------------------|------------------|---------------------|
| <i>Essential</i> | <i>Desirable</i> | <i>Non Required</i> |

Table 20.



Going forward we will develop use cases functional specification both for the data measurable at the PoC, defining the minimum accuracy, measurement granularity, and resolution of data capture, and for the data relevant to the PoC, defining means of data transfer and other relevant specifications.

This will inform a gap analysis in each of the DNO's networks, to understand what the cost of retrofitting existing DER would be, either to make a DER visible or if it is already visible, the cost of meeting the technical specification previously defined. The gap analysis will also be carried out for the data relevant at the POoC.

Benefits that the enhanced DER visibility would bring to each use case will then be quantified and be used to derive a cost benefit analysis (CBA).

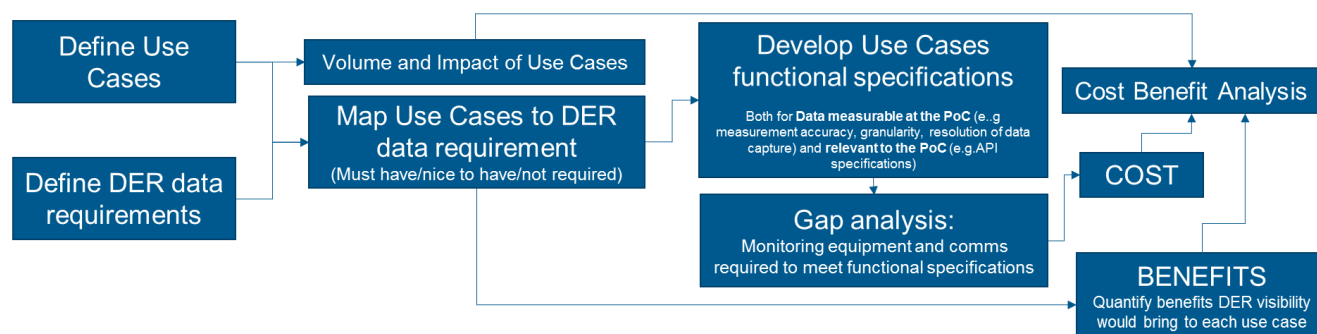

Figure 1: Proposed approach

This report presents the output of the first two steps namely definition of use case, DER data requirements and volume and impact of use cases.

### 3. Operational DER data Definition and Scope

#### 3.1. Operational DER Data Definition

The product team has identified DER operational data, both as the data available at the PoC, and data relevant to the PoC, described below; future assessments will inform whether or not the product should limit the scope to include only the data available at the PoC.

**Data available from the Point of Connection** refers to Real-time operational telemetry data ‘measurable’ at the point where the DER connects to the network in terms of active, reactive power etc used for power system operational visibility and in some cases dispatch instructions. It requires components, such as current transformers, voltage transformers, IED devices (relay, transducer, PQM) remote terminal units (RTU), wiring, communication infrastructure and a system that makes use of the real-time operation data such as DNO's Network management System (NMS) and ESO's Energy management System (EMS) as shown in Figure 2.

**Data relevant to the Point of Connection**, refers to all other data that is relevant to the DER PoC which are not necessarily measured at the PoC, including forecasted generation profiles, market data including volumes and activation windows, as well as static data DER data. These data could be obtained from a number of different sources such as online database, third party platforms, aggregators, Balancing mechanism (BM) systems, online portals, user submitted code-related data etc.



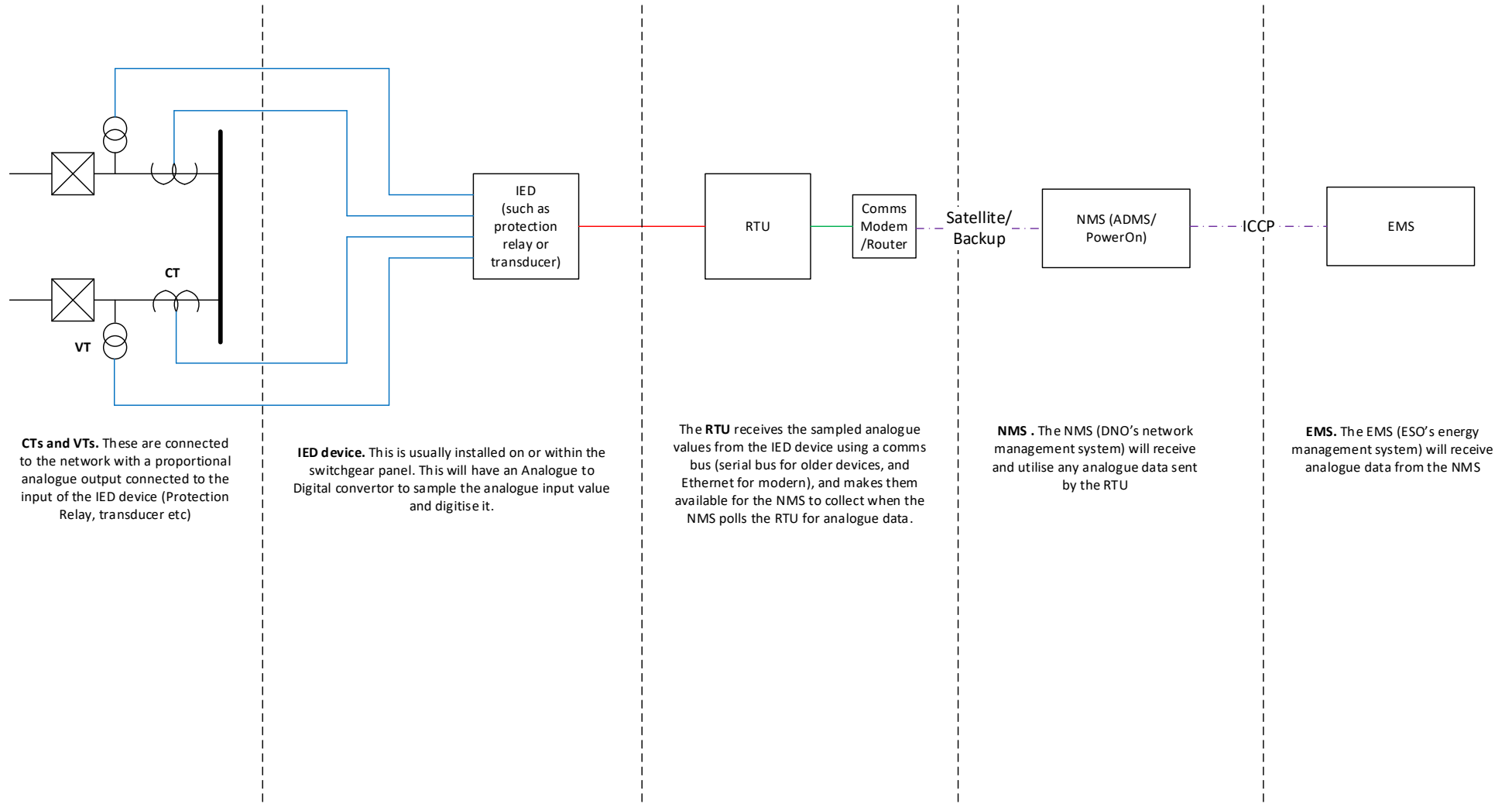

Figure 2: Overview of monitoring equipment for Operational DER data

### 3.2. DER in Scope

The product team has defined the following boundary conditions for investigating the uses and needs of Operational DER monitoring and visibility:

#### DER POC Voltage Level

DERs that have a PoC voltage between 132kV kV bar at Grid Supply Points (GSP) and 11kV bar at secondary substation as shown in Figure 3.

#### DER Capacity Size

DERs that have a capacity falling into G99 monitoring requirements:

- Type A (<1 MW),
- Type, B, C, D (>1 MW)

#### Connection Date

Applicable to both existing and new DERs. New DGs connecting to the network are mandated to have appropriate monitoring and controlling equipment as per G99 requirements. It is envisioned that the recommendation made within the WS1B P6 shall also be applied retrospectively to existing DERs.

#### DER types

Applicable to all DER types including Distributed Generators (DG), battery storage, and demand. The CBA will investigate each type to ascertain whether the monitoring requirements identified have enough benefits to justify investment.

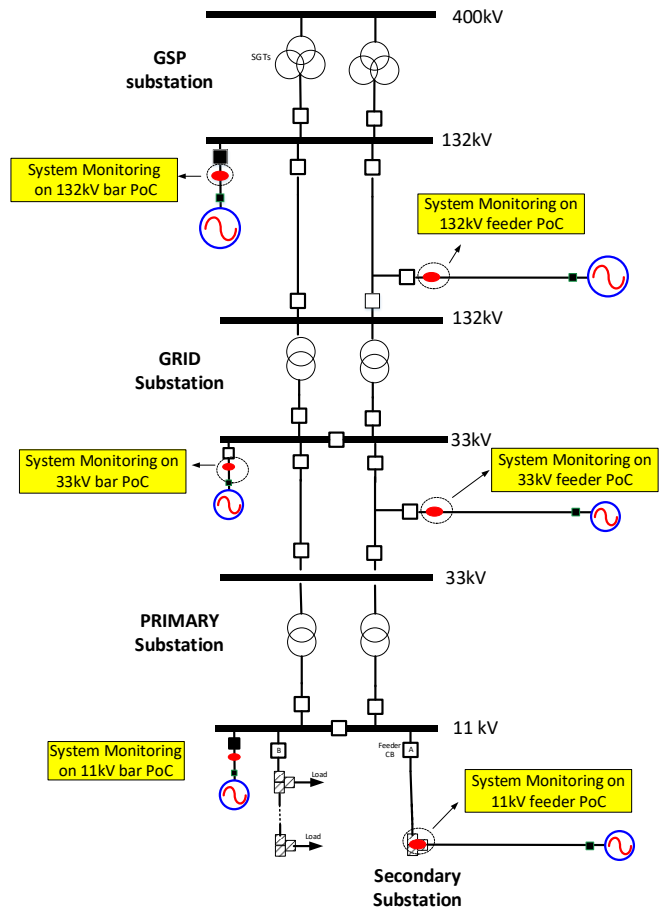

Figure 3: Operational DER visibility - Voltage boundary

## 4. Use Cases Definition

The Product team has identified fourteen use cases that will benefit from enhanced operational DER visibility and monitoring and has classified them in five main categories, as shown in Table 1. The use cases captures all prospective DER-DNO/ESO interactions (service or activity) that will make use of data applicable to the PoC. The use cases that stem from sharing of DER data between the DNO and ESO are not in scope of this product.

Table 1: Use Cases Definition

| Use Cases Definition                           |    |   |
|--|----|---|
| Category                                       |    | Use Case  |
| DER providing service to DNO only              | 1  | Flexible Connections dispatch (ANM)   |
|  | 2  | Flexibility Service dispatch  |
| DER providing service to ESO only              | 3  | Ancillary and Balancing services  |
|  | 4  | System Restoration (Black Start)  |
|  | 5  | Capacity Mechanism Planning   |
| DER providing services to a DNO and ESO        | 6  | Whole system coordination (resolving conflicts of services)                       |
| All DER –<br>Improvement of existing processes | 7  | Improved System Resilience  |
|  | 8  | Improved real-time Network Operation  |
|  | 9  | Improved Outage Planning (DNO)/<br>Network Access Planning (ESO) processes        |
|  | 10 | Improved Network Planning (DNO)/<br>Long-term network development (ESO) processes |
|  | 11 | Improved Demand forecasting processes   |
|  | 12 | Real-time DSO Data transparency   |
| Market Facilitation (Non-DSO services)         | 13 | DER compliance with relevant standards  |
|  | 14 | Facilitation of new Markets (e.g. peer-to-peer)                                   |

The sections below describe the use case and list out the uses and/or benefits of DER monitoring and visibility.

### 4.2. DER providing service to DNO only

#### 4.2.1. Flexible Connections dispatch

Some parts of the network cannot accommodate additional generation, or energy storage, capacity without the risk of breaching network limits. These areas would require significant network modifications or upstream reinforcements to be able to accommodate the new connections in an unconstrained manner. Utilising active network management system, Flexible Connections output is managed in operational timescales through a curtailment instruction during times of network congestion when the pre-defined thresholds are breached.

DER PoC data are essential to configure the scheme in the ANM system, to enable real time dispatch, as well as to verify that the DER responds as expected following a curtailment instruction. Additional DER PoC data such as forecasted DER output is beneficial to carry out curtailment baselining activities to assess the uncurtailed profile had it not been curtailed by ANM.

### 4.2.2 Flexibility Service Dispatch

Procuring and dispatching Flexibility Services allows DNOs to reduce peak demand during congestion caused by incremental load growth, by “turning down” Flexible Demand or “turning up” Flexible Generation”, under different products (Secure, Sustain, Dynamic, restore), as an alternative approach to traditional network reinforcement.

Currently DERs participating in Flexibility Services are asked to provide a metering data at the end of every month to enable DNOs to verify the provision of Flexibility Services following the dispatch instruction. Real-time operational DER monitoring and dispatch capabilities would be beneficial to have visibility of DER load or generation output as well as to enable direct dispatch of Flexibility Service provider. This will allow to have more efficient closer to real time flexibility markets, avoiding to over-procure and over-dispatch DER to cater for the possibility that DERs do not respond. DER visibility will also enable real-time verification of DER service provision. Furthermore availability of granular real-time data allows for accurate Baseline calculations that are used for the quantification and settlement of Flexibility Services.

## 4.3. DER providing service to ESO only

### 4.3.1. Ancillary and Balancing Services

Ancillary and balancing services are procured, dispatched and settled by the ESO. These services are procured through the design and administration of various markets to ensure economic and efficient operation of the national transmission system. The primary role of NGENSO is to continually balance demand and generation on a second-by-second basis, whilst also ensuring that the transmission system is always operated in accordance with the appropriate codes and standards. Examples of services procured to enable the ESO to maintain its overall licence obligations include Frequency Response and Reserve services (e.g. Dynamic Containment and STOR), constraint management services and, increasingly, reactive power & network stability services.

Active Balancing Mechanism Units (BMUs) are required to submit a variety of data to the ESO in order to provide the commercial operating parameters of a given unit. Real-time operational metering data is traditionally provided via the Transmission Owners (TOs) SCADA networks, whilst high accuracy settlement metering is captured for each BMU and provided directly to Elexon. BM unit data and ESO instructions are communicated via both Electronic Data Transfer (EDT) and Electronics Data Logging (EDL) protocols, or the newer Application Protocol Interface (API) which uses more modern web services. The latter has been introduced as a cost-effective alternative to help remove barriers to entry and facilitate competition enabling participation of smaller aggregated units in the BM.

For providers that are not already part of the BM, or who have not signed up to the more modern Wider Access API, the provision of real-time operational visibility and monitoring would likely provide two key advantages for the ESO:

1. It would enable the ESO to build a better real-time picture of DER output in areas where services may need to be dispatched, thus leading to more economic and efficient use of existing service providers.
2. It could potentially allow the expansion of existing ESO services to other, smaller providers in order to increase competition, whilst enabling settlement and enhanced performance monitoring of service provision.

It should be noted that, for the purposes of this product, a generic set of data requirements has been considered by the ESO which cover the basic needs of most balancing services. These have been derived as a means of reducing the overall number of use cases within the product to a manageable level and are likely to provide significant value over and above the data that is available today. In addition, as new services are developed as part of ongoing market-reform work, these data requirements may change depending on the requirements of these new services.

### 4.3.2 System Restoration (Black Start)

In an unlikely event of a blackout, system restoration through DG can be used to restore power to the transmission network through a process known as black start. During a black start event, the service requires the DG provider to start up its main generator(s), carry out initial energisation, support sufficient demand to create and control a stable 'power island', and eventually resynchronize the island to distribution network and the national electricity transmission system through a bottom-up approach. The availability of PoC data from DER are required for planning, dispatch and restoration activities of black-start events.

### 4.3.3 Capacity Mechanism Planning

The Capacity Mechanism (CM) is a market-based activity carried out by the ESO to secure the availability of generation capacity during times of peak demand on the network. The facilitation of this market arrangement ensures national peak demand can always be met, with an appropriate margin to cater for any generation unavailability or potential variance in demand forecasts.

The availability of PoC data from DERs will enable the Capacity Mechanism planning process to be improved (i.e. a better understanding of DER output trends across GB could potentially lessen the CM requirements across peak demand scenarios). It will also help to evolve the current understanding of how different plant types operate across changing market conditions.

## 4.4. DER providing service to a DNO and ESO

### 4.4.1 Whole system coordination (resolving Conflicts of Services)

The ESO has procured balancing services for many years that employ short notice instructions to participants connected to the distribution system, requiring them to alter their demand or generation in return for payment. The opportunities for customers to offer Flexibility Services to the DSO are now growing and, as the number of flexibility service providers increases, there is likely to be an increase in the stacking of transmission and distribution services by service providers. Consequently, there is also an increase in potential for conflicts arising between ESO and DSO service requirements.

Conflict of service can occur during periods of time where the needs of the transmission system operator and the distribution system operator do not align. In addition, the action of automated control systems can also cause a conflict where select parties have their output automatically adjusted, in isolation of services required to manage wider transmission and distribution system needs. An example of service conflict can arise when the service requirements between ESO and DNO are in opposite directions (i.e. generation turn-up instruction from ESO, and turn-down from DNO), whereas if the instruction is in the same direction, e.g. Demand turn up instruction both from DNO and ESO, it would benefit both parties and would not constitute a service conflict. Two service conflict examples are described below.

#### ESO gen turn up instruction, could conflict with generation turn down /demand turn up services from DNO.

In an event where the ESO instructs a STOR generator to ramp-up by 20MW because demand on the transmission is greater than forecasted. However by doing so this would then trigger a nearby Flexible Connections windfarm controlled by Active Network Management (ANM), to reduce output by the same capacity, nullifying the initial request from the ESO.

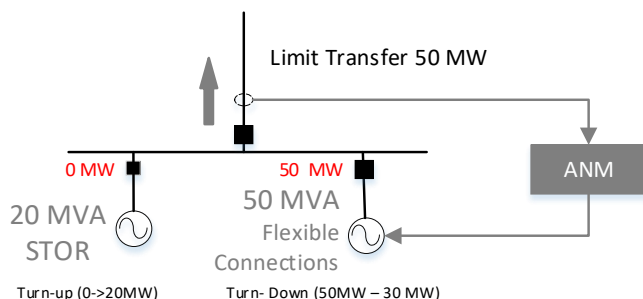

Figure 4: Service Conflict – turn up

ESO gen turn down instruction, could affect with demand turn down/generation turn up instructions from DNO.

In an event where the ESO instructs a STOR generator to ramp-down by 20MW because demand on the transmission is lower than forecasted. However, doing so would trigger a nearby industrial site managed by Flexibility Service, to reduce its demand by the same capacity, nullifying the initial request from the ESO.

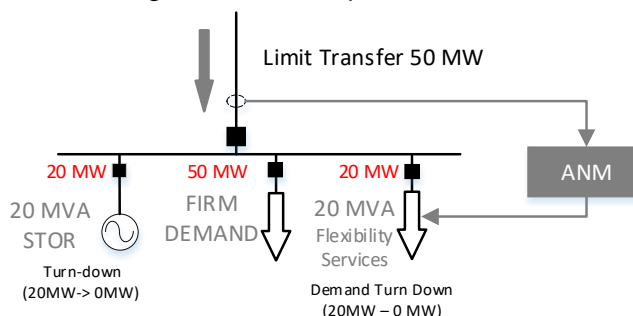

Figure 5: Service Conflict – turn down

Different types of conflicts require different Operational DER data to identify and resolve the conflict, both in planning and operational timescale. To determine whether one service will negate or partially negate another, it will require some consideration of where the services are impacting the network and the locations of the desired change: a comparison can be made looking at the asset ID, the date and time of the service to be delivered along with the type of service being delivered.

## 4.5. All DER – Improvement of existing processes

### 4.5.1. Improved System Resilience (Major network event recovery)

System resilience is related to the ability of a system to withstand and immediately respond to dynamic, transient, or voltage instability disturbances arising from unexpected disruptive events such as large-scale loss of transmission or generation facilities (due to e.g. extreme weather conditions) and ensuring that power supplies are maintained and restored promptly following the event.

Availability of real time operational DER PoC monitoring, direct dispatch links to the DERs is key to take informed remedial action: by quickly communicating the required dispatch schedules or directly dispatching them and confirming that they are responding as required, will enable to respond promptly to events threatening system resilience.

### 4.5.2. Improved real-time network operation

Real-time network operation refers to all use cases that require real-time operational DER visibility to enhance situational awareness enabling improved and faster decision making. Sub-use cases are described below.

- ▶ Manual network switching from control engineers

These refer to core activities which keep the network operation within design limits and maintain security of supply, including planned switching operations, supplies restoration following faults, response to network emergencies and network maintenance. Increased Operational metering from DER will enhance the level of visibility and control.

- ▶ Automatic fault restoration programmes (APRS/PORT)

APRS/PORT uses telemetry data from the network to locate a fault and can then automatically execute a sequence of switching actions to isolate the fault and restore power to the rest of the network minimizing customer interruption time. PORT/APRS determines the load of the feeders by monitoring the pick-up load at the feeder breaker, and then checks if this can be transferred to any of the neighbouring donor circuits.



In a situation where the aggregated generation contribution on the feeder is balanced by the aggregated load on the feeder, the generation would be 'masked' which could cause network an overload when APRS transfers the load on the donor circuits, potentially affecting CI and CMLs. Having telemetry data visibility of individual DG sites on the HV network, and modifying the APRS restoration algorithm to make use of these data (not included in the scope of this product) would allow APRS carry out any switching actions eliminating the risk of overloading assets due to masked generation.

▶ Real-time automatic reconfiguration to maximise network capacity

Due to the large pickup of electric vehicles and heat pumps forecasted at distribution level, the peak demand for electricity is expected to increase significantly. In order to accommodate this increased demand, DNOs reinforce the existing network assets to provide more capacity which takes time and costs money. Some DNOs are trialling a responsive, automated electricity network that re-configures itself in real-time, moving spare capacity to where the demand is, by changing open points on the network and optimising the behaviour of the Soft Open Points (SOPs) and Soft Power Bridges (SPBs).<sup>4</sup>

Wider access to telemetry data from demand and DG will enable more informed switching actions and optimised network performance.

▶ Real-time fault level management

Fault level issues may limit the connection of distributed generation if the fault level contribution of a DER exceeds the switchgear rating: reinforcement works involving the replacement of switchgear with higher-rated equipment has traditionally been the only alternative to accommodate additional distributed generation or battery storage to the network. Several DNOs including WPD, SPEN and UKPN, are now trialling a real-time fault level management which allows to connect DG capacity cheaper and faster.

The system includes real time fault level monitors which communicate fault level information real-time through SCADA to a system such as Active Network Management which makes use of the data and recommends reconfiguration to redistribute power flow to keep fault level below the switchgear rating level.

Fault level monitors are outside the scope of WS1B P6 as they are not PoC DER data, however availability operational DER data is required for the real time-fault level management application to operate.

**4.5.3. Improved Outage Planning (DNO) / Network Access Planning (ESO) activities**

Outage planning activities cover identification of outage requirements from Long Term Outage Planning to Day Ahead activities to ensure the network is compliant for credible network events such and planned and unplanned outages

Availability of PoC DER data and in particular Operational Forecasting will allow outage planning activities to transition away from using worst-case operational scenarios (maximum generation in coincidence with minimum demand) for modelling (where this DER data is currently unknown) to using forecast DER load and generation data. Making use of operational forecasting data in the outage planning processed, as opposed to worst-case assumptions, could lead to less conservative assumptions and increased access to network capacity for customers during outage conditions.

**4.5.4. Improved Network Planning (DNO) / Long-term Network Development(ESO) activities**

---

<sup>4</sup> <https://innovation.ukpowernetworks.co.uk/projects/active-response/>

Visibility of all historical operational DER profiles allow improvement existing network planning activities both at transmission and distribution level including

- ▶ Generation, demand and battery storage connection studies, as well as Flexible Connections curtailment assessment
- ▶ Electricity Network Development, including reinforcement and Asset Replacement to maintain compliance with all relevant legislations, codes and regulations
- ▶ Delivery of more informed submission including FES and DFES (Transmission and Distribution Future Energy Scenarios), ETYS (Electricity Ten Year Statement), NOA and DNOA (Network and Distribution Network Option Assessment), PLE (Planning Load Estimates), LTDS (Long Term Development Statement) and LI (Load Index) risk.

#### 4.5.5. Improved Demand Forecast Processes

Operational forecasting is a key activity within the ESO business and is a key enabler for DNOs to transition towards distribution system operator (DSO) role.

At DSO level, Operational demand forecast will enable activities such as network constraints and curtailment forecast in operational timescales and well as loading forecasting on flexibility sites, which will allow to procure and dispatch flexibility based on forecasted network needs. Operational Demand forecast will also enable outage planning and real time network operation activities to secure the network based on future network states.

Demand Forecasting is a core process within the ESO business that provides confidence over the availability of generation to meet national demand at different cardinal points throughout a 24-hour period, this is essential for the ESO to be able to carry out its primary role as overall energy balancer. The demand forecast is built utilising a number of data sources, historical information and detailed modelling to ensure adequate generation is available to cover national demand requirements. In addition, it is used to help schedule appropriate system response, reserve and margin services.

ESO has developed a cloud-based platform for energy forecasting (PEF) which makes use of advanced statistical learning, machine learning modelling techniques and automation.

The forecasting module uses BM operating schedules for similar periods in previous years to get an idea of an operating envelope for that plant at a particular time, these will then be scaled to take account of expected weather forecasts across the different technology types. Closer to real-time, this information is substituted for market information (i.e. physical notification - PN).

The availability of DER PoC data especially for DER not participating in BM, will enable the demand forecasting process to be greatly improved as the ESO will be able to gain a better understanding of 'pure' consumer demand changes vs. net reductions in demand as a result of smaller DER connecting across the distribution network. This will improve the overall accuracy of the demand forecast across various cardinal points, whilst also enabling a repository of information to be built across various DER technology types which will further enhance forecast capabilities into the future. Accurate forecasts not only support the safe and reliable operation of the grid, but also encourage cost effective operation by improving the scheduling of generation and reducing the use of reserves.

#### 4.5.6. Real-time DSO data transparency

In June 2019 the Energy Data Taskforce, jointly commissioned by Government, Ofgem and Innovate UK, set out five key recommendations to modernise the UK's energy system and drive towards a net zero carbon future

To build such a system DNOs are making their operational data open and freely available to customer and stakeholders that could help them to making better operational decisions. For example, UK Power Networks’ [DSO Dashboard](#) and WPD’s [Live Data feed](#). This also allows DNOs to have a clear aggregated picture of exactly what is happening on the network in real time.

The platform shows the real-time active and reactive power flowing through the network at GSP level, as well as the real-time aggregated generation output GSP per technology type and the total connected generation capacity per GSP. In the foreseeable future additional functionalities may include forecasting generation data and carbon intensity per GSP.

Since not all the generation connected to the distribution network is metered, the aggregated generation data per GSP provided by the platform does not necessarily reflect the total real-time generation. The aggregated unmetered generation, located especially on the HV network, may not be negligible with respect to the metered generation on the EHV network, hence increasing the visibility of DER will allow to have more accurate data, which become essential if customers start using the platform data to make operational investment decisions.



Figure 6: Snapshot of a typical DSO Dashboard (UKPN example in figure).

#### 4.5.7. DER Compliance with relevant standards

DGs connecting to the distribution network are required to comply with relevant standards such as Distribution Code as well as EREC, Connection agreement, G99 requirements etc. Operationally DNOs don’t always have adequate measurements from the DG site to monitor and verify DG compliance with relevant standards, such as power factor of operation, voltage step changes, flickers and harmonics, ramp rates etc.

Enhanced DG visibility will facilitate DNO activities in verifying DG compliance.

### 4.6. Market Facilitation (Non-DSO Services)

#### 4.6.1. Facilitation of new markets

DNOs are considered to have a cardinal role in the facilitation of the new markets in addition to directly procured DSO services, such as peer-to-peer trading platforms including trading of capacity and trading of flexibility to take on or avoid curtailment<sup>5</sup>.

<sup>5</sup> [open-networks-2020-ws1a-p6-non-dso-services-final-report.pdf](https://open-networks-2020-ws1a-p6-non-dso-services-final-report.pdf) (energynetworks.org)

**WS1B P6 Operational DER Visibility and Monitoring**

Use cases, Volumes, and DER Data Points  
July 2021

New markets such as peer-to-peer trading could utilise capacity on the network through non-traditional methods and allow the value of that capacity to be determined through market-based mechanisms. Current innovation projects are exploring the development of these new markets and how distribution network companies can best support non-DSO services.

- ▶ **TRANSION** (SSEN): Exceeding Maximum Import Capacity (MIC) or Maximum Export Capacity (MEC) (P2P) – A service where one Market Actor within a constrained area can increase the level of export or import at one of its MPANs through purchasing excess Authorised Supply Capacity for a period of time from another Market Actor in the same constrained area<sup>6</sup>
- ▶ **Energy Exchange** (UK Power Networks): The market-based curtailment should incentivise the participation of low-cost and optimally-sited generators allowing constraints to be relieved in the most efficient manner. Participants would include their true opportunity cost of curtailment. This will help these parties earn revenues, reduce the cost of curtailment and reduce losses.<sup>7</sup>

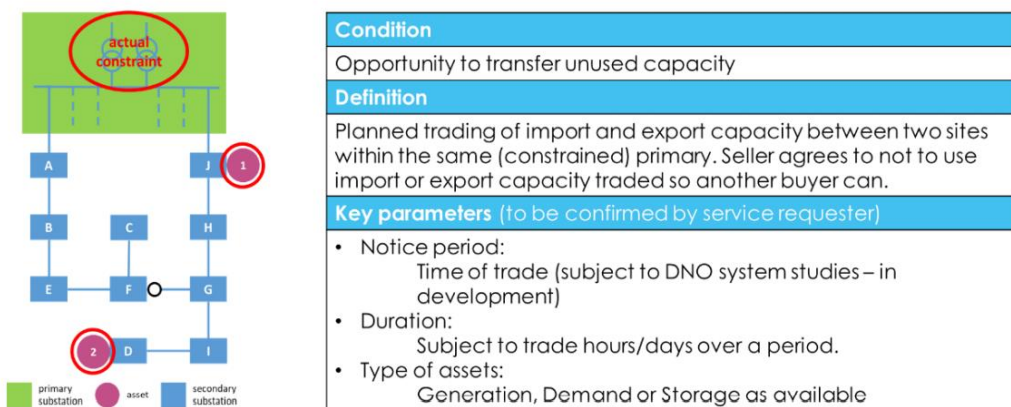

Figure 7: TRANSION – source: [Service-Description-Report-Final-Web.pdf \(ssen-transition.com\)](#)

Operational metering to monitor real-time power production or consumption is essential to facilitate peer-to-peer trading, as well as communication link between participants. WS1A P6 is undertaking analysis on how DNOs can facilitate sharing and trading of capacity, creating scalable interfaces that allow these markets.

<sup>6</sup> <https://ssen-transition.com/get-involved/peer-to-peer-capacity-trades/>

<sup>7</sup> <https://innovation.ukpowernetworks.co.uk/projects/energy-exchange/>

## 5. Volume and Impact of Use Cases

Use cases have then been quantified in terms of Volume of real-world instances and impact that each of them have. The impact of each use case is assessed under three categories; network risk, commercial risk and stability of GB system perspective.

- ▶ Volume: frequency of occurrence of the use case and as an extension, how often does the use case makes use of the operational DER data.
- ▶ Impact: that low DER data accuracy/resolution or complete lack of DER visibility can have on use case
  - Network Risk: risk of overloading or damaging physical network assets/safety of personnel;
  - Commercial: risk of lost revenues/ losses from the market participants;
  - Stability GB system – risk of partial shutdown/blackout of the GB system.

A score that takes into account the combined contribution of volume and impacts is determined as the sum of the impact scores, times the volume score. The score of the use cases could then be taken into account during the CBA stage: the DER monitoring associated to a use case with a high volume and high impact could be given a higher weight with respect to a use cases with a low volume and low impact.

Volume, impacts and the final score results per use case are shown in Table 2.

The volumes and impact score of a number of use cases are described below:

- Flexible Connection dispatch use case is considered to have high frequency of occurrence, as ANM system is continuously polling DER data. If communication with a DER is lost or bad quality data are detected, the DER will be 'failsafed' and as a consequence the use case has a low(1) network risk. During the 'failsafe' period however the DER will be prevented from exporting, largely impacting revenues from export of electricity, hence the use case is considered to have a high(3) commercial risk.
- Flexibility Service dispatch use case is considered to have a lower frequency of occurrence than the Flexible Connections dispatch use case as DER are dispatched only during service delivery season. DER under Flexibility Service do not have failsafe mechanism in place, hence not having real-time visibility of DER output is considered to have a medium(2) network risk (not high as it can be mitigated by manual action from control engineers), especially with more and more DER contracted to provide Flexibility Services. Moreover, not having monitoring also will require to over procure and over-dispatch to cater for the situation where the DER do not respond to a DNO instruction, which is considered to have medium(2) commercial risks.
- System resilience (major network recovery) use case is considered to have low(1) frequency of occurrence, a medium(2) commercial risk and high(3) network and stability of the GB system risk.
- Improvement of demand forecasting processes is considered to have a high(3) volume/frequency (forecasting continuously polling data and re-assessing), and because inaccurate forecast may lead to inaccurate dispatch of services, less availability, and inaccurate view of the network loading, it is considered to have a medium(2) impact on network risk and a high(3) commercial and stability of GB system risk.

Table 2: Volume and Impact of Use Cases

| THEME                                       | #  | USE CASE  | Volumes    | Impact       |                 |                     | Score |
|---|----|---|------------|--------------|-----------------|---------------------|-------|
|   |    |   |            | Network Risk | Commercial Risk | Stability GB system |       |
| DER providing service to DNO only           | 1  | Flexible Connections dispatch   | High (3)   | Low (1)      | High (3)        | Low (1)             | 15    |
|   | 2  | Flexibility Service dispatch  | Medium (2) | Medium (2)   | Medium (2)      | Low (1)             | 10    |
| DER providing service to ESO only           | 3  | DER providing ancillary and balancing services                                | High (3)   | Medium (2)   | High (3)        | Medium (2)          | 21    |
|   | 4  | DER providing System Restoration (Black start)                                | Low (1)    | High (3)     | Medium (2)      | High (3)            | 8     |
|   | 5  | Capacity Planning Mechanism   | Medium (2) | Medium (2)   | Medium (2)      | High (3)            | 14    |
| DER providing services to a DNO and the ESO | 6  | Whole system coordination (resolving Conflicts of Services)                   | Medium (2) | High (3)     | Medium (2)      | Medium (2)          | 14    |
| All DER - Improvement of existing processes | 7  | System resilience   | Low (1)    | High (3)     | Medium (2)      | High (3)            | 8     |
|   | 8  | Improved real-time Network Operation  | High (3)   | High (3)     | Medium (2)      | Medium (2)          | 21    |
|   | 9  | Improved outage planning processes (DNO)/Network Access planning (ESO)        | High (3)   | High (3)     | Medium (2)      | Low (1)             | 18    |
|   | 10 | Improved Network Planning processes (DNO)/Long-Term Network Development (ESO) | Medium (2) | Medium (2)   | Medium (2)      | Low (1)             | 10    |
|   | 11 | Improved demand forecasting processes   | High (3)   | Medium (2)   | High (3)        | High (3)            | 24    |
|   | 12 | Real-time DSO data transparency   | High (3)   | Low (1)      | Low (1)         | Low (1)             | 9     |
|   | 13 | DER compliance with relevant standards  | Low (1)    | Low (1)      | Low (1)         | Low (1)             | 3     |
| Market facilitation (Non-DSO Services)      | 14 | Facilitation of new markets (e.g. peer-to-peer)                               | High (3)   | Low (1)      | Medium (2)      | Low (1)             | 12    |

## 6. DER Data Points identification

A comprehensive set of DER data points that may be required and/or be beneficial for the identified use cases, have been identified and is captured in Table 3, The DER data points have been classified based on the categories below:

- ▶ Raw POC data: DER data originating from a measurement device/physical equipment. These include operational metering, weather data, power quality monitoring and customer metering data.
- ▶ Processed Data: DER data that requires processing/analytical steps.
- ▶ Forecasted Data: DER data either coming from a forecasting platform which takes as an input historical data and weather data, or declaration of forward-looking availability from the DER
- ▶ Availability Data: DER data on the availability of the DER affected by planned/ unplanned generation outages.
- ▶ Market Data: DER data detailing service DER is participating in including flexibility requirement, service window, and delivery season etc.
- ▶ Static Data: offline DER data including capacity, PQ envelope, protection settings, ramp rates etc.
- ▶ Other real-time data, includes RTU points such as read back signals and mode of operation.

Note: The data attributed “real time” refers to data acquired in real time and not necessarily used in real time.

Table 3: DER data points

| Category       | Data Point               | Description   |
|----------------|--------------------------|---|
| Raw POC data   | Amps                     | Measured Current at point of connection   |
|                | Volts                    | Measured Voltage at the point of connection   |
|                | MW                       | Measured Active Power at point of connection  |
|                | MVAR                     | Measured Reactive Power at point of connection  |
|                | Power Factor (PF)        | Measured Power Factor at point of connection  |
|                | Frequency (Hz)           | Measured Frequency at point of connection   |
|                | Breaker/Isolator status  | Indication of the open/ close status of the isolating switchgear  |
|                | Power quality monitoring | Power Quality measurement including Harmonics, Sag, Swell, Flickers etc   |
|                | Weather Data             | Weather data at the DER site including wind speed, temperature, solar irradiation and angle   |
|                | Metering/settlement data | Metered electricity supplied by or sold to an authorised electricity supplier.  |
| Processes Data | Load Factor              | The load factor of a DER is the instantaneous output divided by its nominal capacity.   |
|                | State of Energy          | Level of charge or discharge of an electric battery relative to its capacity. It gives an indication of how much longer a battery can continue charging or discharging at the maximum (or actual) power |
|                | Power Available          | The potential maximum power output of a wind or solar farm based on weather conditions. The ‘Headroom’ can be calculated as the difference between the Power Available and the real time output.        |

|                      |  |  |
|----------------------|--|--|
| Forecasted Data      | MW Forecasted /Declared MW output            | Generation Forecasting from DER at the point of connection<br>Declaration of Availability at the point of connections  |
|                      | DER Availability (0/1)                       | Signal is used to inform the DNO that the DER is under maintenance and unable to receive instructions.   |
| Availability Data    | MW Capacity in Service                       | Indication of percentage of DER MW capacity in service, relative to total plant rating at commissioning.   |
|                      | Planned DER outage                           | Visibility of future DER planned outages   |
| Market Data          | Service Contracted                           | Service(s) the DER has been contracted to provide (includes both DNO and ESO services)   |
|                      | Volume and time window of Service contracted | Volume of capacity, Time Windows and delivery season the DER has been contracted to provide these service(s).  |
|                      | Volume and time window of service forecasted | Volume of capacity, duration/ time windows the service is forecasted/scheduled to be required for.   |
|                      | Volume of service dispatched                 | Volume of capacity that has been dispatched (real time) per each service   |
| Static Data          | Capacity (export/import)                     | This is the total MW export and import capacity permitted as per the connection agreement.   |
|                      | POC Voltage                                  | The voltage at the Point of Connection to the distribution network.  |
|                      | P/Q capability curve                         | Points describing the reactive power capability of a power generating module in the context of varying active power at the point of connection                             |
|                      | Technology Type                              | DER technology Type including Fuel and Asset type.   |
|                      | Protection Settings                          | Generator's protection settings including Loss of Mains (LoM) protections (RoCoF/VS), under-voltage (U/V), Overvoltage (O/V), Under-frequency (U/F), Over-frequency (O/F). |
|                      | Control mode                                 | Mode of Operation the DER must operate in based on connection agreement. (PQ/ PV control)  |
|                      | Fault Infeed parameters                      | DER sub-transient and transient fault infeed parameters  |
|                      | Ramp-up and ramp-down rates                  | Maximum ramp-up and ramp-down rates configured on the customer control system for active power export.   |
|                      | Minimum DER partial power                    | Minimum allowable load at which a generator can reliably operate, as a percentage of its rated capacity.   |
|                      | Address/coordinates                          | Coordinates, Address and Postcode of the DER Site  |
|                      | MPAN   | Core meter point administration number, a 13-digit reference used to identify the relevant Metering Point.   |
|                      | DER ID                                       | IDs used to identify the DER (Site Number /Unique BMU ID)  |
| Other real time data | MW, MVAR, volts read back signals            | Feedback of the Active Power, reactive Power and Voltage limit provided by customer control system confirming acknowledgement of the control signal.                       |
|                      | DER mode of operation                        | The DER current service/mode of operation which DER sends out via its RTU to indicate what service they are providing (P, V, Q or PF)                                      |
|                      | Failsafe State                               | Feedback of the received "Failsafe" digital controls confirming acknowledgement of the action  |



## 7. DER Data Points to Use Case Mapping

For each of the use cases, the identified data points have been categorized as “Essential” (E), “Desirable” (D) or “Not required” (N) data points. The complete table mapping is available in Table 18, Table 19 and

|                  |                  |                     |
|------------------|------------------|---------------------|
| <i>E</i>         | <i>D</i>         | <i>N</i>            |
| <i>Essential</i> | <i>Desirable</i> | <i>Non Required</i> |

Table 20.

Justification of the data points’ requirement per each use case is described in the tables below.

Where relevant the data points could be provided to one or both parties.

*Table 4: Flexible Connections Dispatch DER Data Requirement*

| Use Case 1 - Flexible Connections Dispatch |   |
|--|---|
| Data Category                              | Use case justification  |
| Raw  | PoC DER operational metering data is required for ANM to determine the contribution of each Flexible Connection to a constraint to calculate the correct curtailment instruction as well as to monitor the response of the DER following the curtailment instruction.<br>PoC DER operational metering data is also required to enable more advanced ANM functionalities such as Load Flow (real-time and near-future network state), Contingency Analysis (to secure the network based on the worst identified fault), State Estimation (used if the quality/availability of the existing measurement is poor), Optimisation functions (for e.g. minimise curtailment). |
| Forecast                                   | DER POC forecast data, would be beneficial to generate networks constraint forecast as well as to determine the curtailment baselining i.e. the uncurtailed DER output profiles of each Flexible Connections had it not been curtailed by ANM.  |
| Availability                               | Real time DER availability (0/1) data point and planned outages information could be beneficial to allow temporarily remove the DER from the LIFO stack for the duration of the outage. Visibility of the capacity in service beneficial for more accurate ANM curtailment calculations.  |
| Static                                     | Static data such as capacity, technology, ramp rates, voltage etc are required to configure the scheme in the ANM system.   |
| Other real time                            | ANM Flexible Connections are required to send read back instruction signals following the receipt of a set-point, and acknowledgement of “failsafe” instruction.  |

*Table 5: Flexibility Service Dispatch DER Data requirement*

| Use Case 2 - Flexibility Service Dispatch |  |
|---|--|
| Data Category                             | Use case justification   |
| Raw                                       | Flexibility providers are not required to be equipped with real time monitoring and dispatch capabilities. Telemetry would be beneficial to enable visibility of the flexibility available, direct dispatch of Flexibility Service provider and real time verification of DER service provision to avoid over procuring and over dispatching of Flexibility. |

**WS1B P6 Operational DER Visibility and Monitoring**

Use cases, Volumes, and DER Data Points

July 2021

|                        |   |
|------------------------|---|
| <b>Forecast</b>        | DER POC forecast data, could be used to generate demand constraint forecast and would enable Flexibility service baselining.  |
| <b>Availability</b>    | Flexibility Providers are required to notify DNO if at any time their assets are unavailable for a future service period, due to planned/ unplanned technical reasons. Real time availability (0/1) data points as well as planned outage information are essential for Flexibility Service dispatch. |
| <b>Market</b>          | Contracted Service window, delivery season and contracted volume of Flexibility are essential market data, as well as volume of service forecasted and dispatched.  |
| <b>Static</b>          | DSO Flexibility Services units are contracted to manage network constraints based on their electrical connectivity to a flexibility zone. Capacity, address and site reference number are required to assess the suitability of flexibility units to participate in Flexibility Services              |
| <b>Other real time</b> | At present Flexibility Service DER are not required to send read back signal/failsafe acknowledgment, this information could be beneficial in the future.   |

*Table 6: Ancillary and balancing services DER Data requirement*

| Use Case 3 - Ancillary and Balancing Services |  |
|---|--|
| Data Category                                 | Use case justification   |
| <b>Raw</b>                                    | The availability of DER operational metering is beneficial to the ESO to allow DER participating in balancing services whilst providing improved visibility actual DER output, to ensure they are responding as required to ESO instructions. Visibility of real time operation of DER participating in Ancillary and Balancing services is also beneficial to the DNOs. |
| <b>Processed</b>                              | Information on the power available i.e. potential headroom of wind/solar generation technology could be beneficial during periods where upward service are required. State of energy/charge for storage units participating in ESO services, is beneficial to determine how long the service may be available for.   |
| <b>Forecast</b>                               | DERs participating in BM are required to submit Physical Notifications (PNs) in the form of MW output profile, in addition to other dynamic parameters. There is no such requirement for units that are not part of the BM.  |
| <b>Availability</b>                           | DERs participating in BM are required to declare their availability  |
| <b>Market</b>                                 | Information of the service volume, the windows DER have been contracted to provide services, as well as volume of service dispatched are captured within the appropriate framework agreement. Depending on the nature of the service, units are then dispatched manually, via the BM or the new 'Platform for Ancillary services (PAS).                                  |
| <b>Static</b>                                 | Ramp rates, capacity, POC Voltage, asset ID, minimum partial power, ramp rates are required to be provided by the DER participating in BM ahead of real-time. Many of these parameters can be altered up to gate closure.  |

*Table 7: System Restoration (Black Start) DER data requirements*

**Use Case 4 - System Restoration (Back Start)**

| Data Category | Use case justification  |
|---------------|---|
| Raw           | DG Operational metering is required to manage DG output to ensure that the island operation remains within safe limits and enable active and reactive power control from the DG sustaining the power island. Operational metering is also required by the local control system sustaining the island for activities such as calculating the load that can remain connected based on the DG generation capacity at the given instance. |
| Processed     | Processed data including battery state of charge could provide information on how long the island can be sustained for if supported by battery storage  |
| Forecast      | DER forecast data could be beneficial to provide information on the duration the island be sustained and demand can be met, if the island is dependent of solar/wind generation.  |
| Availability  | Information on the availability of the units contracted to provide black start services.  |
| Static        | Static data such as capacity, technology, PQ capability curve, control mode, fault infeed and protection setting are used to assess the suitability of the DER to sustain the pick-up load of the island without violating network parameters.  |

*Table 8: Capacity mechanism planning - DER data requirements*

| Use Case 5 - Capacity Mechanism planning |   |
|--|---|
| Data Category                            | Use case justification  |
| Raw                                      | The availability of PoC data from network-wide DERs will enable the Capacity Mechanism (CM) planning process to be improved, providing a better understanding of DER output trends across GB which could potentially lessen the CM requirements across peak demand scenarios. |
| Forecast                                 | Forecasted DER data from the POC could be beneficial to assess the impact on the net demand on the CM requirements.   |
| Market                                   | Information on the services DERs are participating to, including volume of service contracted and time windows/season of activation, could be beneficial to assess the impact on the net demand on the CM requirements.   |
| Static                                   | Static data such as capacity, voltage level, technology type, minimum DER partial power, fault infeed parameters are required for Capacity mechanism planning.  |

*Table 9: Conflict of Service - DER data requirements*

| Use Case 6 - Whole system coordination (resolving conflicts of services) |   |
|--|---|
| Data Category  | Use case justification  |
| Raw  | POC operational DER data is required to have greater visibility of the real time operation as well as the available flexibility.  |
| Processed  | Power available and state of charge are desirable information that could be used into the service conflict resolution.  |
| Forecast   | Having forward visibility of what a DER will be requested to do by each of the service will enable forward scheduling and identification of alternative options to meet ESO or DNO flexibility requirements |

|                 |  |
|-----------------|--|
| Availability    | Information of forward visibility due to planned outages could be integrated into the ESO and DNO dispatch platforms.  |
| Market          | Information on the date and time of the service to be delivered along with the type of service being delivered could help planning ahead avoiding service conflict if any other units could be dispatched instead. |
| Static          | Information such as capacity, voltage level technology, ramp rates, are required to configure the flexibility provider in the DNO and ESO platform   |
| Other real time | Read back and failsafe signals are desirable.  |

Table 10: Improved System resilience –DER data requirement

| Use Case 7 - Improved System Resilience |   |
|---|---|
| Data Category                           | Use case justification  |
| Raw                                     | Availability of operational DER monitoring is key to enable ESO and DNO to respond promptly to events threatening system resilience. Direct dispatch links to the DER would be beneficial to take faster remedial action. Monitoring is required to confirm that DER are responding as required to instructions fro ESO/DNOs. |
| Processed                               | Power available and state of charge information could benefit system restoration activities.  |
| Forecast                                | Forecasted generation output could be beneficial during events threatening system resilience, to inform how total whether related generation output could vary and affect system frequency.   |
| Availability                            | Indication on whether the DER is in service or not is useful information during system restoration activities   |
| Market                                  | Visibility of the services DERs have been contracted to provide and visibility of services (e.g. STOR) dispatched in real time.   |
| Static                                  | Capacity, voltage, ramp rate, technology, site number, Protection settings are required.  |

Table 11: Improved real time operation – DER data requirement

| Use Case 8 - Improved Real Time Network operation |  |
|---|--|
| Data Category                                     | Use case justification   |
| Raw   | Availability of operational DER monitoring is required for real time network operation to enhance situational awareness enabling improved and faster decision making, including manual and automatic network switching.<br>Availability of operational DER monitoring is also required for online network analysis such as load flow (also based on future network states), contingency, state estimation, optimisation etc. |
| Processed   | Power Available and state of charge could benefit real time network operation  |
| Forecast  | Access to forecasted DER data could be beneficial for the system to estimate future network loading of level of fault level in the network and recommend pre-active remedial actions   |
| Availability                                      | Information on planned outages, capacity in service, real time availability is required for real-time network operation.   |
| Static  | Capacity, POC, site number, technology type, control mode and fault level information is required for real-time network operation.   |

*Table 12: Improved Outage Planning activities - DER data requirement*

| Use Case 9 - Improved Outage Planning Activities |   |
|--|---|
| Data Category                                    | Use case justification  |
| Raw  | Visibility of historical DER operational data, including MW, MVAR, Amps, Volts, PF is required for outage planning activities.  |
| Forecast   | Making use of operational forecasting data in the outage planning activities could lead to less conservative assumptions and increased access to network capacity for customers during outage conditions. |
| Availability                                     | Visibility of DER outage data (e.g. for planned maintenance) or outages affecting the DER export is required for outage planning activities   |
| Static   | Capacity, technology, PoC voltage, fault infeed parameters, site number and minimum DER partial power are required for outage planning activities.  |

*Table 13: Improved Network Planning activities – DER data requirement*

| Use Case 9 - Improved Network Planning activities |   |
|---|---|
| Data Category                                     | Use case justification  |
| Raw   | Enhancement of DER operational visibility including MW, MVAR, Amps, Volts, PF allow improvement existing network planning activities.   |
| Forecast  | Long term forecast could benefit planning activities such as FES/DFES   |
| Static  | Capacity, export, P/Q capability curve, protection settings, control mode of operation, fault infeed are required for network planning activities. Ramp rate desirable to study voltage step changes caused by DER ramping up and down. |

*Table 14: Improved demand forecasting activities – DER data requirements*

| Use Case 10 - Improved Demand Forecasting activities |   |
|--|---|
| Data Category  | Use case justification  |
| Raw  | DER PoC data especially for DERs not participating in BM, will enable the demand forecasting process to be greatly improved as the ESO will be able to gain a better understanding of 'pure' consumer demand changes vs. net reductions in demand as a result of smaller DER connecting across the distribution network.<br>Weather data at the DER POC could yield in more accurate demand forecasting data. |
| Forecast   | DER forecast from customers especially from non-Solar and non-wind generators (small scale conventional and battery storage), which depends on combination of commercial signal and not   |

**WS1B P6 Operational DER Visibility and Monitoring**

Use cases, Volumes, and DER Data Points

July 2021

|              |  |
|--------------|--|
|              | only weather conditions, would greatly benefit the demand forecasting activities. This forecast from the DER customer could be integrated into the main ESO/DNO central forecasting platform     |
| Market       | Information on service(s) DERs are participating in, including volume of service contracted and time windows/season of activation, could be beneficial to improve demand forecasting activities. |
| Availability | Forward unavailability due planned outages could be accounted for in the demand forecasting.   |
| Static       | Static data including capacity, technology, PoC voltage, ramp rates, coordinates and technology type are required for demand forecasting activities.   |

*Table 15 Improved real time DSO data transparency - DER data requirements:*

| Use Case 11 -Improved real time DSO data transparency |  |
|---|--|
| Data Category   | Use case justification   |
| Operational Metering                                  | Network wide operational metering including MW and MVAR are required to have an accurate view of the total generation output across DNOs network. Because of unmetered generation especially on the HV, total aggregated real time output may not correspond to the aggregated generation in the network |
| Forecast Data   | Forecasted DER output at the POC could be integrated into the real time transparency platform, to provide visibility of the real time and forecasted total generation at each GSP  |
| Static Data   | Capacity, technology type and site ID are the static data points required. Technology type is used to quantify the total installed and real time generation capacity per GSP and could also be used in the future for visibility of the carbon intensity.  |

*Table 16: DER compliance with relevant standards – DER data requirements*

| Use Case 13 - DER compliance with relevant standards |  |
|--|--|
| Data Category  | Use case justification   |
| Operational Metering                                 | Operational metering is required to verify compliance with relevant standard/connection agreement: such as the historical maximum export and import capacity defined in the connection agreement; the power factor of operation stipulated in the connection agreement; compliance with EREC such as voltage step changes; over/ under-voltage limit stipulated in the distribution code; verification of ramp rate requirements specified by G99, as well as power quality assessment |
| Static Data  | Static data such as capacity, PoC voltage, P/Q capability curve, control mode and protection settings are required to verify DER compliance with relevant standards.   |

*Table 17: Facilitation of new markets (e.g. peer-to-peer) – DER data requirements*

| Facilitation of new markets (e.g. peer-to-peer) |   |
|---|---|
| Category  | Use case justification  |
| Raw   | Operational metering between parties exchanging services is required to facilitate peer-to-peer trading closer to real time and enable automated execution of peer-to-peer transactions |

**WS1B P6 Operational DER Visibility and Monitoring**  
 Use cases, Volumes, and DER Data Points  
 July 2021

|                     |  |
|---------------------|--|
| <b>Processed</b>    | Power available and state of energy is beneficial to facilitate peer to peer trading such as trading capacity and curtailment as it gives information on the headroom available to be provided to market participants and the duration that services from battery storage could be provided for. |
| <b>Forecast</b>     | DER Forecast data would allow market participant to bid closer to real time for network capacity and curtailment, based on forecasted volumes of generation.   |
| <b>Availability</b> | DER availability and visibility of outages is beneficial to facilitate peer to peer trading.   |
| <b>Static</b>       | MPAN, contractual mode, PQ envelope, minimum partial power are required  |

Table 18: Use case Mapping 1

|                          |  | Flexible Connections dispatch (ANM) | Flexibility Service dispatch | Facilitation of new markets |
|--------------------------|--|-------------------------------------|------------------------------|-----------------------------|
| <b>Raw POC data</b>      | Amps   | E                                   | D                            | E                           |
|                          | Volts  | E                                   | D                            | E                           |
|                          | MW   | E                                   | D                            | E                           |
|                          | MVAR   | E                                   | D                            | E                           |
|                          | Power Factor (PF)                            | D                                   | D                            | D                           |
|                          | Frequency (Hz)                               | D                                   | N                            | D                           |
|                          | Breaker and Isolator status                  | E                                   | D                            | E                           |
|                          | Power quality monitoring                     | N                                   | N                            | N                           |
|                          | Weather Data                                 | D                                   | D                            | D                           |
|                          | Metering/settlement data                     | N                                   | E                            | D                           |
| <b>Processed data</b>    | Load Factor (%)                              | N                                   | N                            | D                           |
|                          | State of Energy (storage) (kWh)              | D                                   | D                            | D                           |
|                          | Power available                              | D                                   | D                            | D                           |
| <b>Forecasted Data</b>   | MW forecasted output                         | D                                   | D                            | D                           |
| <b>Availability Data</b> | DER Availability (0/1)                       | D                                   | E                            | D                           |
|                          | MW Capacity in Service                       | D                                   | D                            | D                           |
|                          | Planned DER outage                           | D                                   | D                            | D                           |
| <b>Market Data</b>       | Service contracted                           | D                                   | E                            | E                           |
|                          | Volume and time window of Service contracted | D                                   | E                            | E                           |
|                          | Volume and time window of Service Forecasted | D                                   | E                            | E                           |
|                          | Volume of Service instructed                 | D                                   | E                            | E                           |
| <b>Static Data</b>       | Capacity (export/import)                     | E                                   | E                            | E                           |
|                          | POC Voltage                                  | E                                   | E                            | E                           |
|                          | P/Q capability curve                         | D                                   | D                            | D                           |
|                          | Technology Type                              | D                                   | D                            | D                           |
|                          | Protection Settings                          | N                                   | N                            | N                           |
|                          | Control mode                                 | D                                   | N                            | D                           |
|                          | Fault Infeed parameters                      | N                                   | N                            | N                           |
|                          | Ramp-up and ramp-down rates                  | D                                   | D                            | D                           |
|                          | Minimum DER partial power                    | D                                   | D                            | D                           |
|                          | Address/coordinates                          | D                                   | E                            | D                           |
|                          | MPAN   | D                                   | E                            | E                           |
| Asset ID                 | E  | E                                   | E                            |                             |

**WS1B P6 Operational DER Visibility and Monitoring**

Use cases, Volumes, and DER Data Points

July 2021

|                      |                                   |   |   |   |
|----------------------|-----------------------------------|---|---|---|
| Other real time Data | MW, MVAR, volts read back signals | E | D | D |
|                      | DER mode of operation             | E | D | E |
|                      | failsafe                          | E | D | D |

|           |           |              |
|-----------|-----------|--------------|
| E         | D         | N            |
| Essential | Desirable | Non Required |

Table 19: Use case mapping 2

|                          |  | Ancillary services or balancing services | System Restoration – Black start | Capacity Mechanism Planning | Whole system coordination (conflicts services) |
|--------------------------|--|--|----------------------------------|-----------------------------|--|
| Raw POC data             | Amps   | E  | E                                | D                           | E  |
|                          | Volts  | E  | E                                | D                           | E  |
|                          | MW   | E  | E                                | E                           | E  |
|                          | MVAR   | E  | E                                | E                           | E  |
|                          | Power Factor (PF)                            | N  | E                                | D                           | N  |
|                          | Frequency (Hz)                               | D  | E                                | N                           | D  |
|                          | Breaker and Isolator status                  | E  | E                                | E                           | E  |
|                          | Power quality monitoring                     | N  | N                                | N                           | N  |
|                          | Weather Data                                 | E  | D                                | E                           | E  |
| Metering/settlement data | E  | E  | D                                | N                           |  |
| Processed data           | Load Factor (%)                              | D  | D                                | E                           | D  |
|                          | State of Energy (kWh)                        | E  | E                                | E                           | D  |
|                          | Power available                              | E  | D                                | E                           | D  |
| Forecasted               | MW forecasted output                         | E  | D                                | E                           | D  |
| Availability Data        | DER Availability( 0/1)                       | E  | E                                | N                           | D  |
|                          | MW Capacity in Service                       | D  | D                                | N                           |  |
|                          | Planned DER outage                           | E  | N                                | E                           | D  |
| Market Data              | Service contracted                           | E  | E                                | D                           | E  |
|                          | Volume and time window of Service contracted | E  | E                                | D                           | E  |
|                          | Volume and time window of Service Forecasted | E  | E                                | D                           | E  |
|                          | Volume of Service instructed                 | E  | E                                | D                           | E  |
| Static Data              | Capacity (export/import)                     | E  | E                                | E                           | E  |
|                          | POC Voltage                                  | E  | E                                | E                           | E  |
|                          | P/Q capability curve                         | D  | E                                | D                           | D  |
|                          | Technology Type                              | D  | E                                | E                           | D  |
|                          | Protection Settings                          | N  | E                                | N                           | N  |
|                          | Control mode                                 | Ds                                       | E                                | D                           | D  |
|                          | Fault Infeed parameters                      | N  | E                                | E                           | N  |
|                          | Ramp-up and ramp-down rates                  | E  | E                                | E                           | D  |
|                          | Minimum DER partial power                    | E  | E                                | E                           | D  |
| Address/coordinates      | E  | E  | E                                | D                           |  |
| MPAN                     | E  | E  | N                                | D                           |  |



**WS1B P6 Operational DER Visibility and Monitoring**  
 Use cases, Volumes, and DER Data Points  
 July 2021

|                             |                                   |   |   |   |   |
|-----------------------------|-----------------------------------|---|---|---|---|
|                             | Asset ID                          | E | E | E | E |
| <b>Other real time data</b> | MW, MVAR, volts read back signals | D | N | N | E |
|                             | DER mode of operation             | D | D | N | D |
|                             | failsafe                          | N | N | N | D |

|                  |                  |                     |
|------------------|------------------|---------------------|
| <i>E</i>         | <i>D</i>         | <i>N</i>            |
| <i>Essential</i> | <i>Desirable</i> | <i>Non Required</i> |

Table 20: Use Case mapping 3

|                          |  | system resilience | real time network operation | Outage planning processes | Improved Network Planning process | Improved Demand Forecasting processed | Real-time DSO data transparency | DER compliance |
|--------------------------|--|-------------------|-----------------------------|---------------------------|-----------------------------------|---------------------------------------|---------------------------------|----------------|
|                          |  | 7                 | 8                           | 9                         | 10                                |                                       | 12                              | 11             |
| <b>Raw POC data</b>      | Amps   | E                 | E                           | E                         | E                                 | D                                     | D                               | E              |
|                          | Volts  | E                 | E                           | E                         | E                                 | D                                     | D                               | E              |
|                          | MW   | E                 | E                           | E                         | E                                 | E                                     | E                               | E              |
|                          | MVAR   | E                 | E                           | E                         | E                                 | E                                     | D                               | E              |
|                          | Power Factor (PF)                            | E                 | D                           | D                         | D                                 | D                                     | D                               | E              |
|                          | Frequency (Hz)                               | E                 | D                           | D                         | D                                 | D                                     | D                               | E              |
|                          | Breaker and Isolator status                  | E                 | E                           | E                         | E                                 | E                                     | D                               | E              |
|                          | Power quality monitoring                     | N                 | N                           | N                         | D                                 | N                                     | D                               | E              |
|                          | Weather Data                                 | N                 | D                           | D                         | N                                 | E                                     | D                               | N              |
|                          | Metering/settlement data                     | N                 | N                           | N                         | N                                 | N                                     | N                               | E              |
| <b>Processed data</b>    | Load Factor (%)                              | D                 | D                           | D                         | N                                 | E                                     | D                               | N              |
|                          | State of Energy (kWh)                        | E                 | D                           | D                         | N                                 | E                                     | D                               | N              |
|                          | Power available                              | D                 | D                           | D                         | N                                 | E                                     | D                               | N              |
| <b>Forecasted</b>        | MW forecasted output                         | D                 | D                           | D                         | N                                 | E                                     | D                               | N              |
| <b>Availability Data</b> | DER Availability (0/1)                       | D                 | D                           | D                         | N                                 | D                                     | D                               | E              |
|                          | MW Capacity in Service                       | D                 | D                           | D                         | N                                 | D                                     | D                               | E              |
|                          | Planned DER outage                           | N                 | N                           | E                         | N                                 | D                                     | N                               | N              |
| <b>Market Data</b>       | Service contracted                           | E                 | D                           | E                         | E                                 | E                                     | D                               | N              |
|                          | Volume and time window of Service contracted | E                 | D                           | E                         | E                                 | E                                     | D                               | N              |
|                          | Volume and time window of Service Forecasted | E                 | D                           | D                         | N                                 | E                                     | D                               | N              |
|                          | Volume of Service instructed                 | E                 | D                           | N                         | N                                 | E                                     | D                               | E              |
| <b>Static Data</b>       | Capacity (export/import)                     | E                 | E                           | E                         | E                                 | E                                     | E                               | E              |
|                          | POC Voltage                                  | E                 | E                           | E                         | E                                 | E                                     | E                               | E              |
|                          | P/Q capability curve                         | D                 | D                           | E                         | E                                 | D                                     | N                               | E              |
|                          | Technology Type                              | E                 | E                           | E                         | E                                 | E                                     | E                               | E              |
|                          | Protection Settings                          | E                 | D                           | D                         | E                                 | N                                     | N                               | E              |
|                          | Control mode                                 | D                 | E                           | E                         | E                                 | D                                     | N                               | E              |
|                          | Fault Infeed parameters                      | N                 | E                           | E                         | E                                 | D                                     | N                               | N              |
|                          | Ramp-up and down rates                       | N                 | D                           | D                         | D                                 | E                                     | N                               | E              |
|                          | Minimum DER partial power                    | D                 | D                           | D                         | D                                 | E                                     | N                               | E              |
|                          | Address/coordinates                          | N                 | N                           | D                         | D                                 | E                                     | N                               | N              |
| MPAN                     | D  | D                 | D                           | D                         | N                                 | N                                     | E                               |                |

**WS1B P6 Operational DER Visibility and Monitoring**

Use cases, Volumes, and DER Data Points

July 2021

|                             |                       |   |   |   |   |   |   |   |
|-----------------------------|-----------------------|---|---|---|---|---|---|---|
|                             | Asset ID              | E | E | E | E | E | E | E |
| <b>Other real time Data</b> | read back signals     | N | D | N | N | E | N | E |
|                             | DER mode of operation | D | D | N | N | D | N | E |
|                             | failsafe              | D | D | N | N | N | N | E |

|                  |                  |                     |
|------------------|------------------|---------------------|
| <i>E</i>         | <i>D</i>         | <i>N</i>            |
| <i>Essential</i> | <i>Desirable</i> | <i>Non Required</i> |

**GLOSSARY**

**APPENDICES**

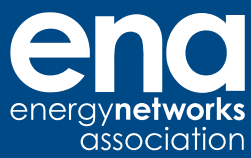

**Energy Networks Association**

4 More London Riverside

London SE1 2AU

t. +44 (0)20 7706 5100

w. [energynetworks.org](http://energynetworks.org)

 [@EnergyNetworks](https://twitter.com/EnergyNetworks)

© ENA 2020

Energy Networks Association Limited is a company registered in England & Wales No. 04832301  
Registered office: 4 More London Riverside, London, SE1 2AU